

# CASUAL OUTDOOR

## MANY WAYS TO MEET

CASUAL OUTDOOR is the weatherresistant version of the CASUAL by Bene collection and is perfect for outdoor use. It's designed to take your productivity and relaxation to the next level! Whether you're working, taking a break, or hosting guests, our

outdoor furniture is the perfect solution for those who want to enjoy fresh air and sunshine. CASUAL OUTDOOR is designed to provide optimal comfort, allowing you to work, rest or socialize with ease!

**Design : Christian Horner**



**bene**

INSPIRING OFFICES. SINCE 1790.

## PRODUCT DESCRIPTION

### CASUAL OUTDOOR BENCH

- ❶ **Seat and backrest:** the substructure consists of an open-pored outdoor foam padding that enables the water to permeate. This ensures rapid drying within a short time, even when the furniture is completely drenched. The cover is easy to remove by means of a zip and can thus also be washed. A Velcro fastener on the seat or backrest enables quick and effortless removal of the cushions.
- ❷ **Armrest:** optional, of zinc-coated steel and black powder-coated.
- ❸ **Legs:** of zinc-coated steel and black powder-coated. Available as a standard or connection leg. With plastic glides.

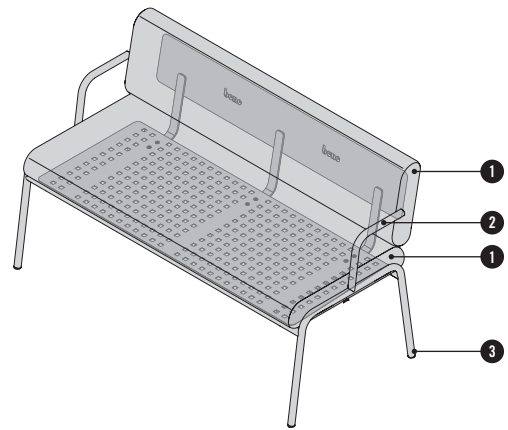

Covers are available in the fabric collection Panama or Artisan by Agora.  
Season: spring / summer, remove the pads overnight or when it rains  
Colour configuration options: single-coloured or different colour for recessed elements.

### UPHOLSTERY OF SEAT SURFACE AND BACKREST

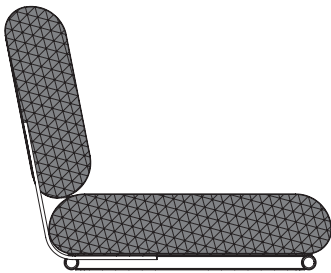

Open-pored outdoor foam padding

### STANDARD LEG

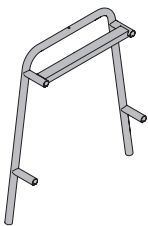

Frame construction made of zinc-coated steel and black powder-coated.

### LINKING LEG

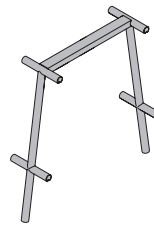

Frame construction made of zinc-coated steel and black powder-coated. Two tubes on the left and right for extensions.

### PLANNING INSTRUCTIONS

Two CASUAL elements are always linked with a linking leg.

## PRODUCT DESCRIPTION

### CASUAL OUTDOOR TABLE

- ① **Tabletop:** FENIX 12 mm
- ② **Frame:** of zinc-coated steel and black powder-coated.

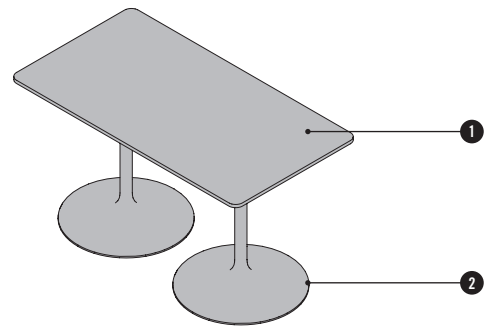

### FOOTREST



Optional. The CASUAL Table High can be configured with a footrest made of zinc-coated steel and black powder-coated.  
Height: 325 mm

## COLOURS & MATERIALS

### FENIX™

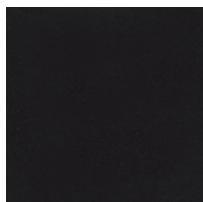

black

## OVERVIEW & DIMENSIONS

### CASUAL OUTDOOR LOUNGE



Chair

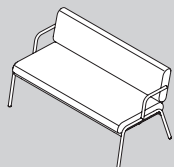
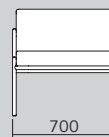
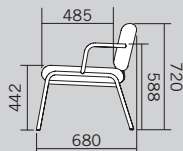

Bench

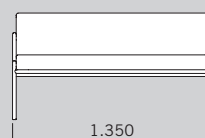
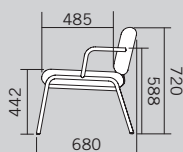

### CASUAL STOOL



Stool Low

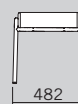
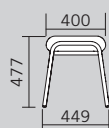

Stool High

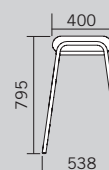

### CASUAL OUTDOOR LOW



Single Bench

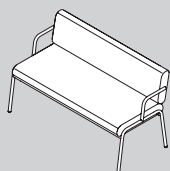
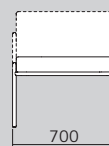
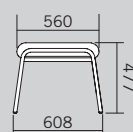
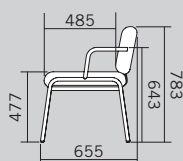
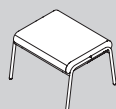

Double Bench

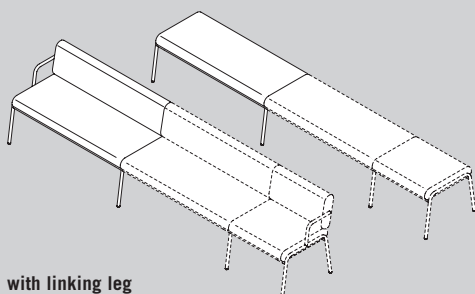
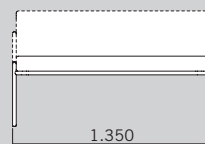
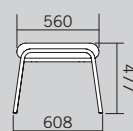
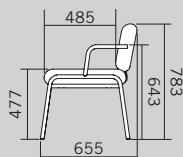
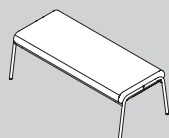

with linking leg

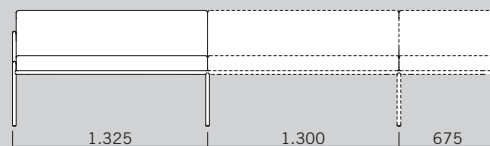
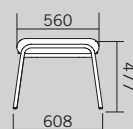
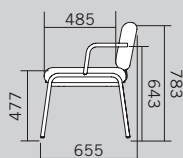

Dimensions in mm

## OVERVIEW & DIMENSIONS

### CASUAL OUTDOOR HIGH



Single Bench

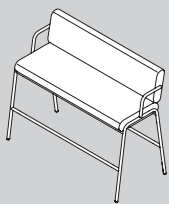
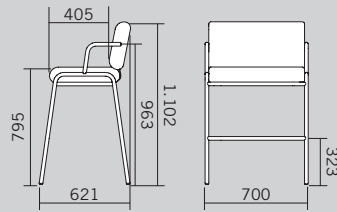

Double Bench

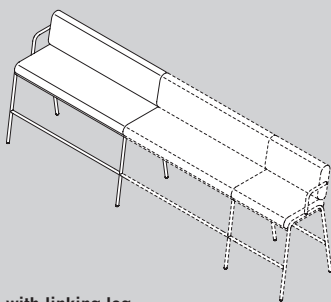
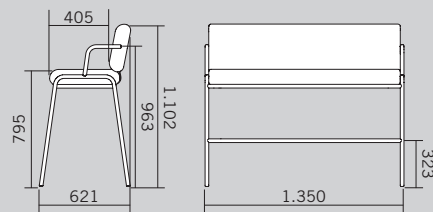

with linking leg

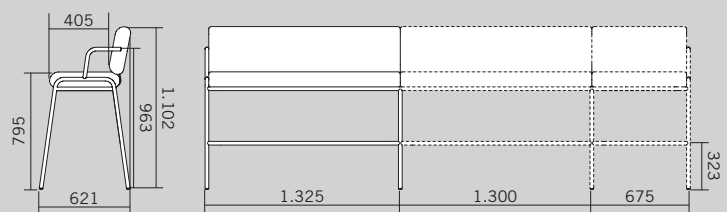

Dimensions in mm

## OVERVIEW & DIMENSIONS

### CASUAL OUTDOOR SIDE TABLE HEIGHT 470

Square



600x600

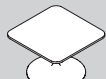

700x700

Round



Ø600



Ø700



Ø800

### CASUAL OUTDOOR TABLE LOW

HEIGHT 740

Square



600x600

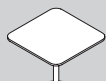

700x700

Round



Ø600



Ø700



Ø800

Rectangular

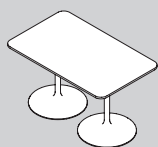

B: 1.300  
T: 700|800|900

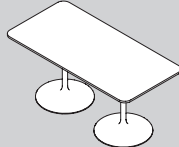

B: 1.625  
T: 700|800|900

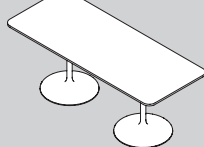

B: 1.950  
T: 700|800|900

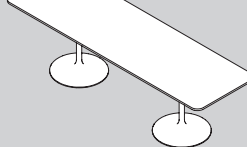

B: 2.600  
T: 700|800|900

Oval



B: 1.300  
T: 700|800|900



B: 1.625  
T: 700|800|900

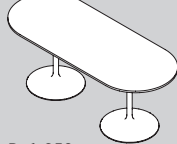

B: 1.950  
T: 700|800|900

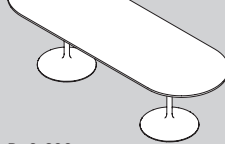

B: 2.600  
T: 700|800|900

### CASUAL OUTDOOR TABLE HIGH

HEIGHT 1.070

Square



600x600

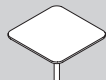

700x700

Round



Ø600



Ø700



Ø800

Rectangular

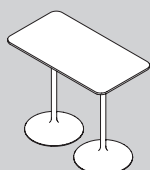

B: 1.300  
T: 700|800

Oval



B: 1.300  
T: 700|800

Dimensions in mm

## APPLICATION

### HEIGHTS

The three heights can be used in different ways.

#### LOUNGE

Seat height

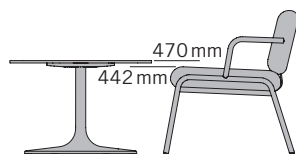

#### LOW

Seat height

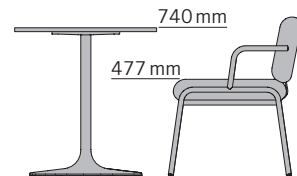

#### HIGH

Standing height

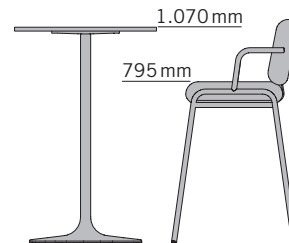

### WIDTHS

There is a matching table for every bench width.

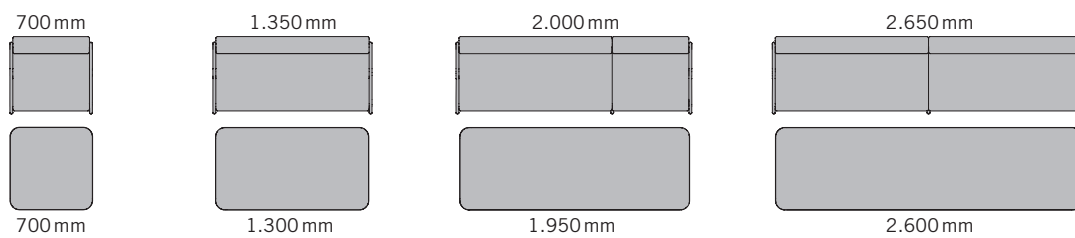

## COLOURS & MATERIALS

### OUTDOOR FABRIC

#### Panama - Agora

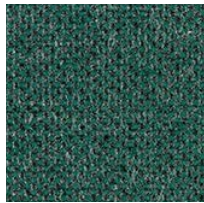

1318 - Emerald

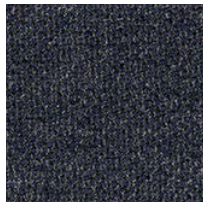

1319 - Navy



1320 - Bone



1321 - Brasserie



1322 - Marble



1323 - Moka

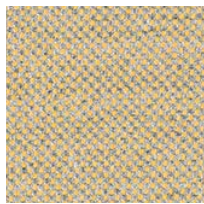

1324 - Mustard



3657 - Onyx



3658 - Cloud

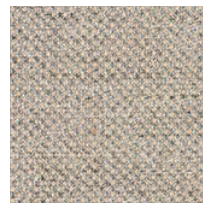

3659 - Fossil



3660 - Cherry

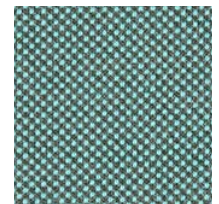

3661 - Ocean

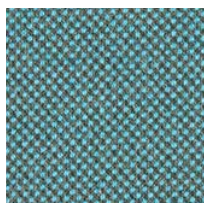

3662 - Lapis



3663 - Flint



3664 - Slate



3665 - Grass

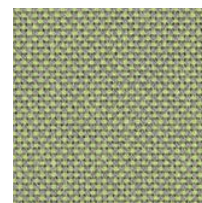

3666 - Green



3667 - Alga

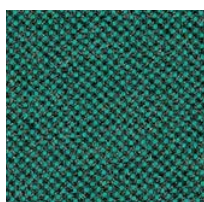

3668 - Basil

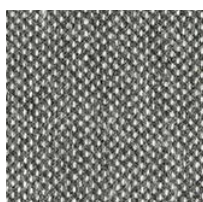

3669 - Stone Grey



3737 - Azafrán

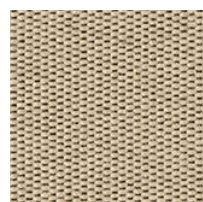

3738 - Beige-Cafe

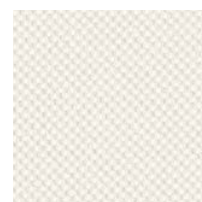

3739 - Blanco



3740 - Integral

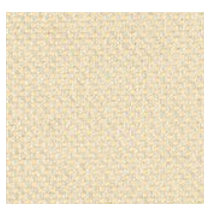

3741 - Marfil



3742 - Mineral

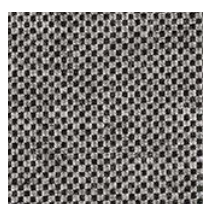

3743 - Ash

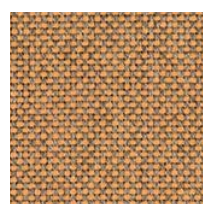

8000 - Tangerine



8001 - Coco

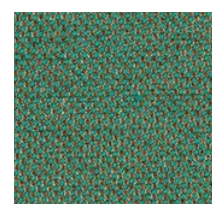

8002 - Oliva

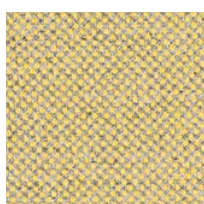

8003 - Citron



8004 - Menta

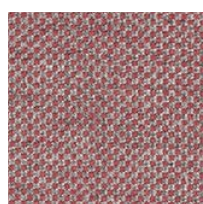

8005 - Scarlet



8006 - Acqua



8007 - Artico



8008 - Lino



8009 - Siena



8010 - Malva



8011 - Brisa



8012 - Garnet



8013 - Grafito



8014 - Ice

## COLOURS & MATERIALS

### OUTDOOR FABRIC

#### Artisan - Agora



1401 - Nacar



1402 - Mineral



1403 - Plomo



1404 - Taupe



1405 - Brisa



1406 - Musgo



1407 - Roca



1408 - Yute

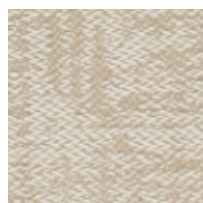

1409 - Arena



1410 - Hueso

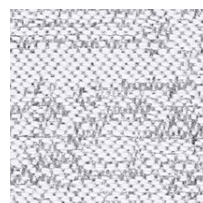

1411 - Niebla

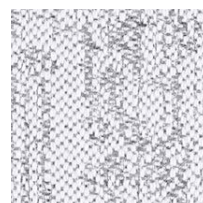

1412 - Perla



1413 - Acero

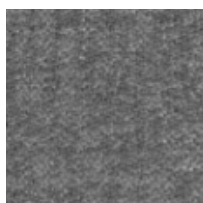

1414 - Humo



1415 - Marengo

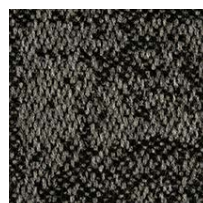

1416 - Grafito

## THE BENE RESPONSIBILITY

Bene plays a pioneering role in the field of sustainability. This spans all company divisions – from product development, procurement, production, and logistics to product recycling. From the first sketch through to series production, ecological requirements are always an important factor in the product development process. It includes selecting environmentally compatible materials, such as certified timbers from sustainably managed forests, using recycled materials and increasing the use of renewable raw materials. Other important requirements for a sustainable product design are labelling the materials, their ability to be repaired, and a long service life for the components used, with the aim to integrate them into a second product life cycle.

To guarantee a high recyclability standard for our products at the end of their service life, we avoid composites as much as possible and develop furniture that allows for disassembly by material type.

Bene products are sourced and made in Europe. 99.9% of all deliveries reach us from a European country. Around 94% of all raw material supplies come from Austria and Germany. Around 93% of the raw materials comes from suppliers within 500 kilometres of our production site.

### SUSTAINABLE RAW-MATERIALS

At Bene, the following materials are used as a matter of course:

- chipboards low in formaldehyde
- glues low in formaldehyde
- water-based varnish systems
- recyclable materials
- materials with a high recycling share
- PVC-free synthetics

Bene guarantees products free from:

- CMR substances
- halogenated solvents in synthetics
- chlorinated hydrocarbons
- heavy metal pigments
- materials with azo pigments
- Coatings with biocidal effects (such as wood preservatives, pesticides).

### CONTRIBUTION TO BUILDING CERTIFICATIONS

In the context of ecological building certification, design systems such as furniture and dividing walls help to achieve a good result and a higher score.

Bene's products make a contribution towards the LEED, WELL Building Standard, DGNB, BREEAM, etc. certifications. Criteria include, for example, environmental product declarations, indoor air quality, acoustics and convertibility.

## CASUAL OUTDOOR

### Example configuration

- Double Bench High
- with backrest
- with armrests
- total weight 28,84 kg

### Environmental key figures

- 100 % sortable by type
- 90,4 % recyclable
- 2,3 % of contents are renewable raw materials
- 39,57 % recycled production materials

### Materials

fabrics  
0,66 kg / 2,29 %

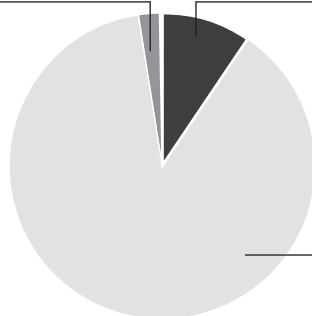

synthetic material  
2,78 kg / 9,64 %

steel  
25,40 kg / 88,08 %

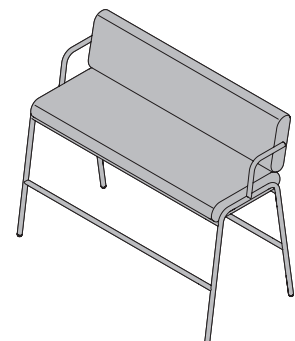

On request, Environmental Product Declarations (EPD, LCA) – at Bene we call them Life Cycle Data Sheets – can be provided for all standard product configurations.

A list of product-specific certificates and design awards can be found on the Bene product website:

Environment-related information about Bene: <https://bene.com/en/sustainability-report-2021/>