

PARCS CAUSEWAY

OXYGEN FOR THE OFFICE

PARCS Causeway is a furniture system that combines bench, fence, screen and storage modules, offering a high degree of design freedom and flexibility. The vertical modules offer a space-shaping effect that can also facilitate screening for focused

working.

The different heights of the Causeway elements encourage users to assume one of three different positions: sitting, standing or leaning, enabling ergonomic freedom.

Design: Pearson Lloyd

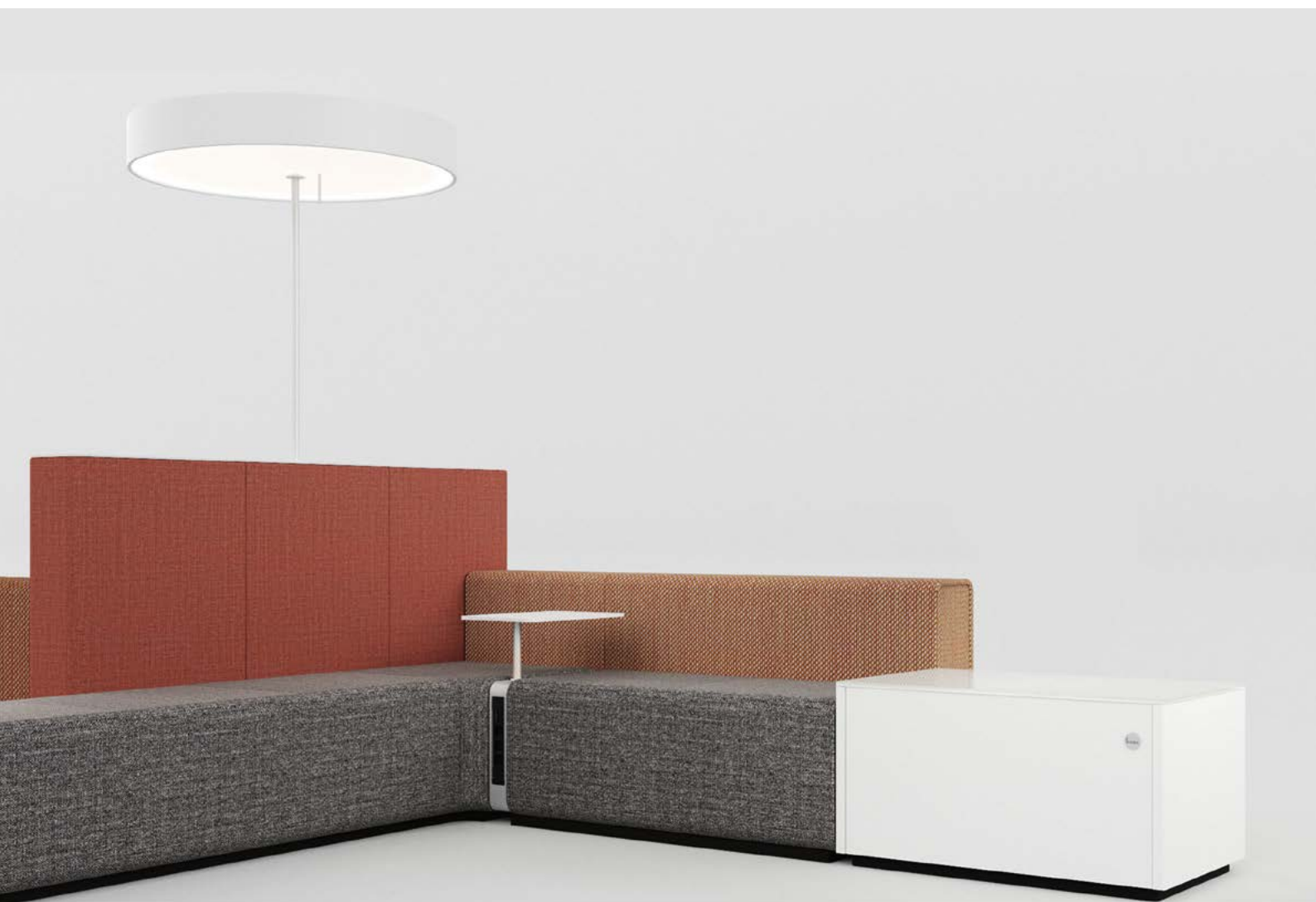

bene

INSPIRING OFFICES. SINCE 1790.

PRODUCT DESCRIPTION

- ① High Fence
- ② Low Fence
- ③ Bench
- ④ Hinged door cabinet for Bench
- ⑤ Parasol Light
- ⑥ Power Bar

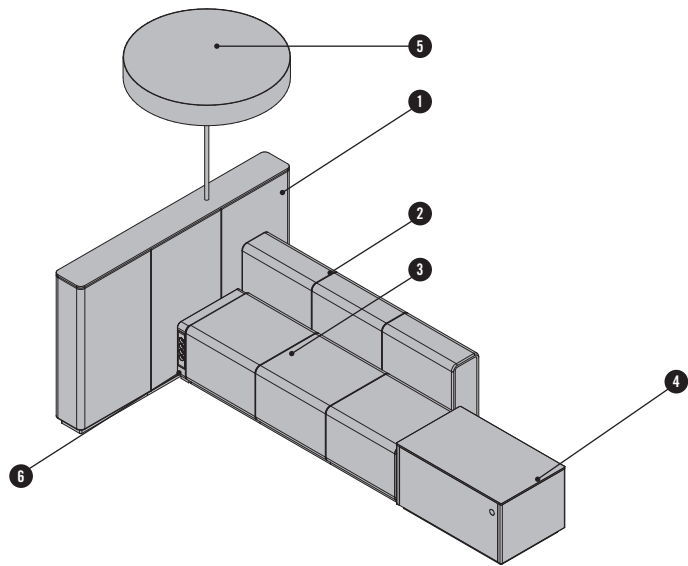

All upholstered Causeway elements have a wooden substructure. Seating elements made with dimensionally-stable polyurethane foam padding. Optionally in flame-resistant version according to BS 5852 Part 2, Ignition Source 5 (Crib 5). Covers always come with double stitching.

BENCH

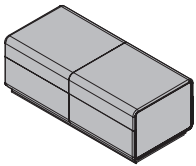

The Benches come in four widths as well as a Corner Bench for corner solutions. Benches can be loosely joined with a base connector. Aluminium base with plastic legs, ± 5 mm can be levelled, with peripheral plastic panelling in black.

HIGH FENCE AND LOW FENCE

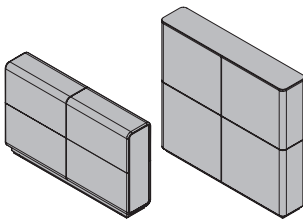

Fences come in 3 widths and 2 heights as well as Corner Low Fence for corner solutions. A Fence must always be supported by an additional element such as a Bench or another Fence. Aluminium base with plastic legs, ± 5 mm can be levelled, with peripheral plastic panelling in black.

The top edges of the Low Fences are padded with dimensionally-stable polyurethane foam. High Fences always come with a top plate, made from either varnished glass, veneered or varnished MDF.

POWER BAR

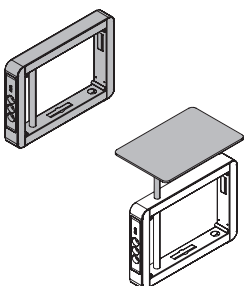

A Power bar can be installed on the side of a Bench but may not be used as an end piece. Steel frame substructure with exterior peripheral panel in AL anodised aluminium. Bene 4-fold connection plug board in black plastic, integrated on the vertical side, cable run from below. Electrical starter cable 5.000mm and 2x Interconnecting cable for CAT6 or HDMI network included. Versions: 4x power socket or 3x power socket, 2x RJ45-CAT6 or 2x power socket or 2x power socket, 2x RJ45-CAT6, 1x HDMI and audio.

Power Bar Table optionally mountable on a Power Bar. Tabletop made of steel pipe with a 30 mm diameter in powder-coated AL aluminium. Maximum load 35 kg. Colours: Varnished MDF (WI white, BS basalt), veneer group 1 oak (EY oak sylt, EV oak volcano); veneer group 2 walnut (NF american walnut) Dimensions: Width 300 mm, Depth 450 mm, Height 420 mm.

PRODUCT DESCRIPTION

HINGED DOOR CABINET FOR BENCH

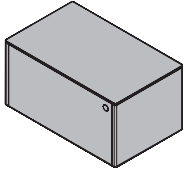

Hinged door cabinets always include a top plate, optionally made of glass or varnished MDF. The carcass can come in varnished MDF white (WI) or basalt (BS), the interior only in melamine white (WI).

Dimensions: Width 900 mm, Depth 550 mm, Height 480 mm

BACKRESTS

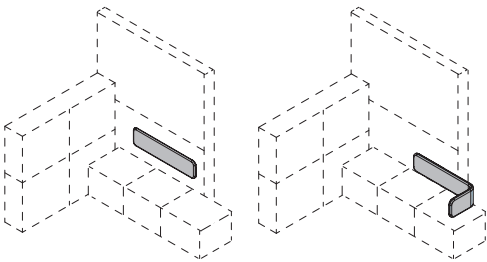

The backrests come flat or angled in different dimensions. The foundation is shaped wood panel upholstered with dimensionally stable polyurethane foam padding.

Assembling backrest, flat
· on the wall/ brickwork using a hook-in rail & two plastic clips

Assembling backrest "L"
· on the wall/ brickwork using a hook-in rail & two plastic clips

PARASOL LIGHT

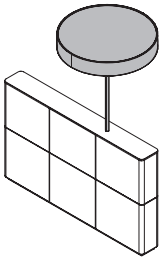

Parasol lights can only be mounted on a High Fence. Lamp shade circumference in fabric or leather. 30 mm lamp tube, powder-coated in AL aluminium. Shade with perspex cover in PW white, satin-coated at top and bottom. Consisting of 8 LED strips (3.000 K) arranged in a circular fashion. They are switched on via a pull switch.

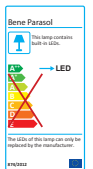

SCREENS

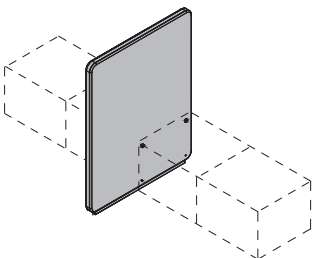

Wooden substructure padded with polyurethane foam. Solid wood base, varnished black. Always insert between two Benches. Connect to the narrow side of the Benches with a fixed connector. In combinations, a Power Bar can only be used on one side of the screen.

OVERVIEW & DIMENSIONS

HIGH FENCE

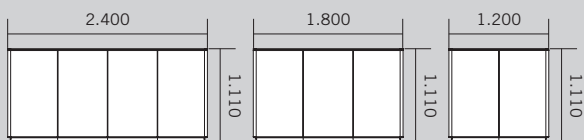

Depth: 230 mm

LOW FENCE

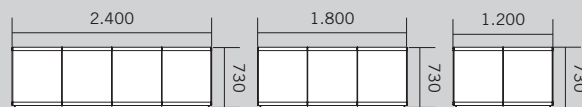

Depth: 230 mm

BENCHES

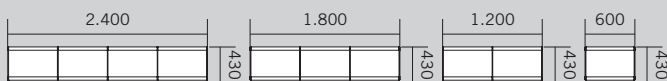

Depth: 550 mm

CORNER BENCH

Depth: 600 mm

CORNER LOW FENCE

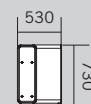

Depth: 530 mm

BACKREST, FLAT



Depth: 50 mm

BACKREST "L"

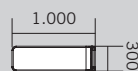

Depth: 400 mm

POWER BAR FOR BENCH



Depth: 70 mm

POWER BAR TABLE



Depth: 300 mm

HINGED DOOR CABINET FOR BENCH

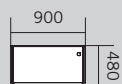

Depth: 550 mm

PARASOL LIGHT

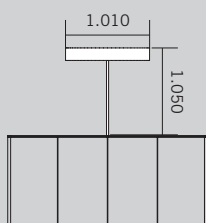

Depth: 1.010 mm

SCREEN

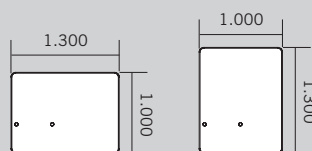

Depth: 65 mm

Measurements in mm

PLANNING LOGIC

PLANNING PARCS CAUSEWAY MINIMAL COMBINATIONS

Some PARCS Causeway elements cannot stand on their own and therefore require a support element. A minimal combination consists of two Causeway elements of which at least one cannot stand freely.

LINEAR MINIMAL COMBINATIONS

Linear minimal combinations consist either of a Bench-Low Fence or Bench-High Fence combination. A stable connection is created with screwed metal Z connectors to the Bench and Fence. The base connector additionally secures against unintentional hanging out. Two Z connector units must be assembled for each minimal combination. The minimum coverage of the Bench and Fence is 1.200 mm. The Z-connector on the fence is 420 mm long, and the connector on the Bench is 100 mm.

- 1 Z connector
- 2 Base connector

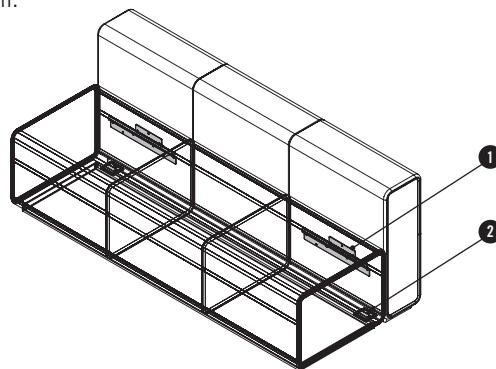

LINEAR MINIMAL COMBINATIONS - CONFIGURATIONS AND LAYOUTS

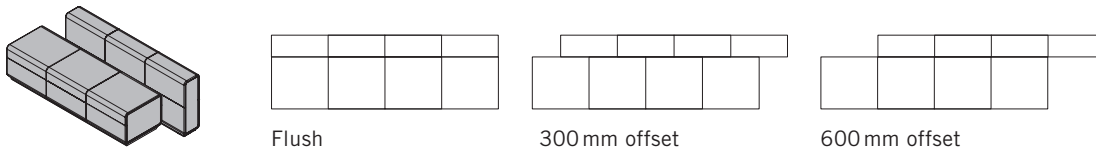

LINEAR MINIMAL COMBINATIONS - DEFINITION OF FITTING POSITIONS

The elements are divided into 300 mm sectors and numbered to define the fittings. The two pairs of fittings are always on the outer edge of the cover.

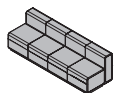

1	2	3	4	5	6	7	8
1	2	3	4	5	6	7	8

Fence 1_2 + 7_8
Bench 1_2 + 7_8

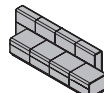

1	2	3	4	5	6	7	8	
	1	2	3	4	5	6	7	8

Fence 2_3 + 7_8
Bench 1_2 + 6_7



1	2	3	4
1	2	3	4

Fence 1_2 + 3_4
Bench 1_2 + 3_4

PLANNING LOGIC

PLANNING PARCS CAUSEWAY MINIMAL COMBINATIONS

Minimal angle combinations

Angle minimal combinations always consist of an initial element and a support element. The support element is always lower than the initial element and is attached offset. Depending on the element, either metal pendant buttons or screws are used as fixed row connectors. The base connector also secures the connection.

- 1 Row connectors
- 2 Base connector
- 3 Initial element
- 4 Support element

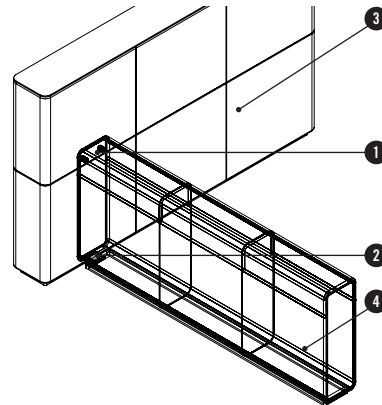

ANGLE MINIMAL COMBINATIONS - CONFIGURATIONS AND LAYOUTS

Low Fence and Bench

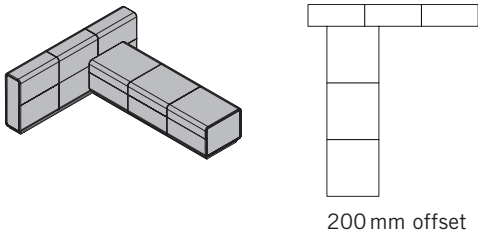

High Fence and Low Fence

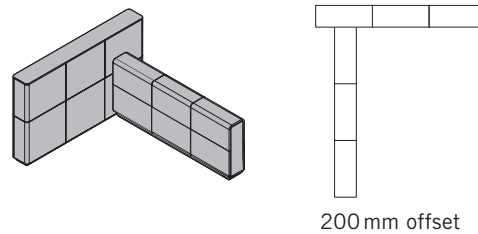

ANGLE MINIMAL COMBINATIONS - DEFINITION OF FITTING POSITIONS

To define the fittings, the initial element is divided into sides A to D.

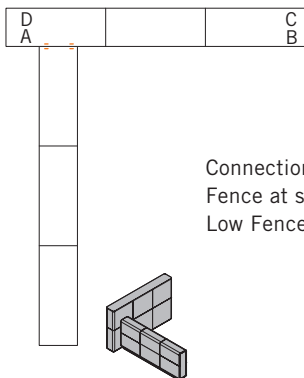

DEFINITION OF SIDES

Bench

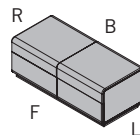

Fence

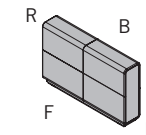

- L left
- R right
- F front
- B back

INSPIRATIONS

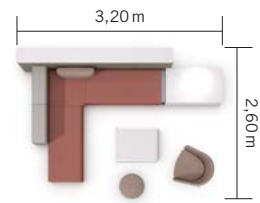

Inspiration #01

Causeway arrangement with Power Bar and hinged door cabinet for Bench.

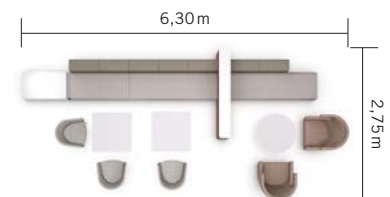

Inspiration #02

Causeway arrangement with Power Bar and hinged door cabinet for Bench.

COLOURS & MATERIALS



Various fabric and leather collections are available for the cover: Era, Urban Plus, Xtreme Plus, Rondo, Step, Step Melange, Remix, Europost, Mainline Flax, Assam, Steelcut, Stamskin Top, Fox, Fiord, Hallingdal, Steelcut Trio, Divina Melange, Divina MD, Coda, Elle, Opera, Entrée, Entrée Color und Superior.

More information about the specific fabric and leather collections is available at www.bene.com.

BENE WORKS SUSTAINABLY

Bene plays a leading role in responsible environmental management. This policy is practised throughout all company divisions – from product development, procurement, production and logistics to product recycling. Bene considers ecology to be a central element of its responsible and sustainable corporate strategy. Bene sees the legal regulations as minimum requirements and strives for better and more sustainable environmental protection throughout the group. Bene's environmental policy principle is: **Avoidance – Minimisation – Recycling – Disposal.**

PARCS CAUSEWAY LOW FENCE – ECOLOGICAL STANDARDS

- 99% recyclable
- 81.20% renewable raw materials
- 42.90% use of recycled product materials (19.34% post-consumer, 23.56% pre-consumer)
- 31.12% use of recycled product materials that comply with LEED (19.34% post-consumer, 23.56% pre-consumer)
- Resource-conserving product design
- Use of materials tested for presence of hazardous substances
- No PVCs, chromium, lead or mercury
- Individual parts can be sorted according to homogeneous categories
- Recyclable, with a positive contribution to the carbon footprint(average 67.4 kg CO₂)

PARCS CAUSEWAY LOW FENCE LEED POINTS

Leadership in Energy and Environmental Design (LEED) is a system developed by the U.S. Green Building Council to classify ecological construction. As an internationally recognised standard, LEED sets out numerous guidelines for environmentally friendly, resource-efficient, and sustainable construction. The use of PARCS Causeway Low Fence is an important contribution to LEED certification. The following criteria for this are from »LEED 2009 for Commercial Interiors«:

MR Credit 4	Recycled content	up to 2 points
MR Credit 5	Regional materials	up to 2 points
IEQ Credit 4.5	Material with low hazardous substance content	up to 1 point

PARCS CAUSEWAY LOW FENCE MATERIAL COMPONENTS

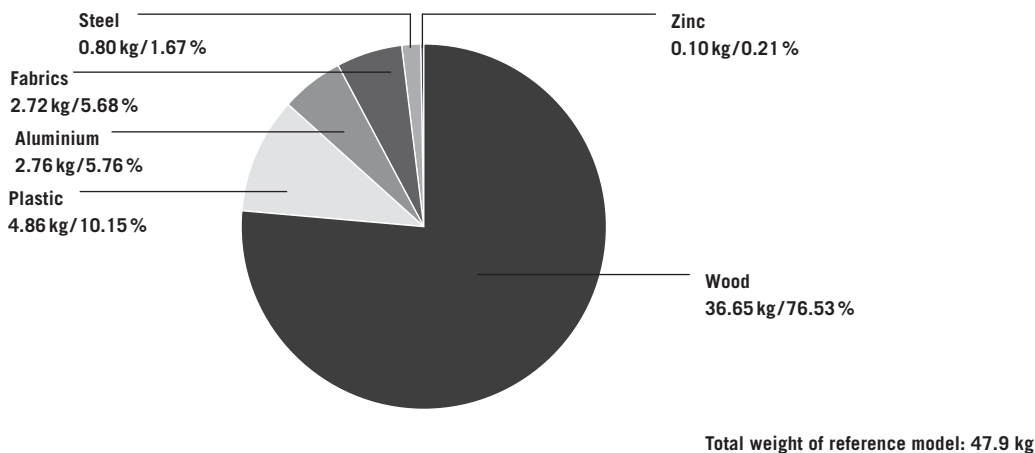

Environment-related information about Bene: www.bene.com/sustainability

